

KF700 Series

Electromagnetic Flowmeter

OPERATION INSTRUMENTS



MF710



MF730

CATALOGS OF SENSORS

1. Operation principle	1
2. Major feature and application	1
3. Structure	2
4. Appearance and install size	3
5. Flow Specifications	4
6. Installation	5
7. Installation site of sensor	7
8. Connecting cable	8
9. Grounding	8
10. The preparation of pre-operational	9
11. Maintenance and common trouble shooting	10
12. Complete sets of products and Open Box	10
13. Quality Assurance	11
14. Transport and storage	11
15. Order Information	11
16. Associated instruments part number and type	11
17. The Corrosion resistance of Common electrode materials	12
18. Performance and application of Common lining materials	12

CATALOGS OF TRANSMITTER

System Description	
I .Instrument installation	
1、 Working conditions	13
2、 Point for attention	13
II .Power line connecting	
1、 Instrument Power supply	14
2、 Instrument power connecting	14
3、 Output Signal	15
III.Instrument started	
1、 The display of Instrument start running	17
2、 User interface of menu	17
3、 Setup of power fuse	18
IV .Instrument operation	
1. Panel structure menu and key define	18
2. Function of manual structure and Description	19
3. Menu item	20
4. Commonly used to guide the functional operation for Transmitter	21
1)Zero Correction	21
2)Unit of Flow	22
3Instantaneous flow Resolution	22
4)Unit of Total	23
5)Cumulative total flow resolution	23
6)Damping time	24
7)Max flow	25
8.)Low cutoff	26
9.)Frequency upper limit HZ	26
10.) Liter/pulse	27
11.) Cumulate Clear	28
V .Technical Data	30
VI.Error message	31
VII.Regular fault treatment	32
1、 Not Flow signal show on LCD display	32
2、 Zero point Instability	33
3、 Instrument show data inconsistent with the actual flow	34
VIII Type selection.	35
VIII I. Transport, storage	35

1. Operation Principle

<>The operation of a magnetic flowmeter or mag meter is based upon Faraday's Law, which states that the voltage induced across any conductor as it moves at right angles through a magnetic field is proportional to the velocity of that conductor.

Faraday's Formula:

E is proportional to $V \times B \times D$ where:

E = The voltage generated in a conductor

V = The velocity of the conductor

B = The magnetic field strength

D = The length of the conductor

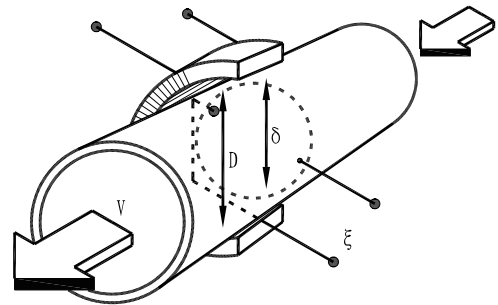

functional diagram

To apply this principle to flow measurement with a magnetic flowmeter, it is necessary first to state that the fluid being measured must be electrically conductive for the Faraday principle to apply. As applied to the design of magnetic flowmeters, Faraday's Law indicates that signal voltage (E) is dependent on the average liquid velocity (V) the magnetic field strength (B) and the length of the conductor (D) (which in this instance is the distance between the electrodes). In the case of wafer-style magnetic flowmeters, a magnetic field is established throughout the entire cross-section of the flow tube (Figure 1). If this magnetic field is considered as the measuring element of the magnetic flowmeter, it can be seen that the measuring element is exposed to the hydraulic conditions throughout the entire cross-section of the flowmeter. With insertion-style flowmeters, the magnetic field radiates outward from the inserted probe (Figure 2).

2. Main Features and Applications

Electromagnetic flowmeter consists of two parts of the sensor and transmitter. KF700-type electromagnetic flowmeter for measuring a variety of acid, alkali, salt solution, paper pulp, slurry and other conductive liquid or liquid-solid two-phase medium volume flow. In the chemical, alloy, water supply and drainage, sewage treatment, food, sugar, paper making, environmental protection and other departments to be widely application.

Following characteristics of sensor:

- (1) The whole welded structure, good sealing performance;
- (2) Structure is simple and reliable, no moving parts inside; virtually no pressure loss
- (3) low-frequency square wave excitation, anti-jamming performance, zero stability;
- (4) The instrument measured medium has nothing to do with pressure, viscosity, temperature, density and other physical parameters of the impact of changes
- (5) The instrument reflects the sensitivity; the output signal has a linear relationship with flow. Width of measurement;
- (6) As measured medium only measuring tube lining and electrode contact, easy to satisfy anti-corrosion, anti-wear requirements;
- (7) Power consumption is small, complete set of instrument power consumption <10VA, has nothing to do with the size of the sensor aperture;
- (8) To install, usage, and easy maintenance.

3. Structure:

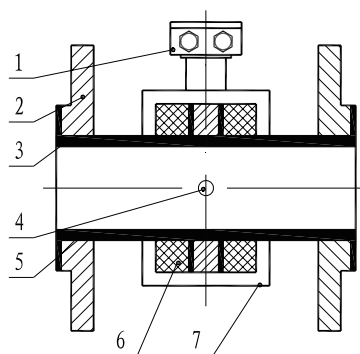

- | | |
|---------------------|---------------|
| 1. Junction box; | 2. flange; |
| 3. insulated liner; | 4. electrode; |
| 5. measuring tube; | |
| 6. excitation coil; | 7. shell |

Structure diagram

Sensor structure shown in Figure 2, the following components:

- (1) Measuring tube: Measuring tube flow measured medium, measuring tube by the non-magnetic stainless steel and welded flange, lined with insulation lining.
- (2) Lining: the inside of the measuring tube and the flange sealing surface of a complete corrosion resistant electrical insulation material, to prevent the traffic signal is short-circuit.
- (3) Excitation system: measurement of the outer tube from top to bottom with a group of coils to generate magnetic fields of work.
- (4) Electrode: with the magnetic field lines perpendicular to the direction of the measurement pipe wall with a pair of electrodes to detect flow signals, the electrode materials can be corrosion testing medium selected.
- (5) Shell: protecting the instrument and steal up it.

4. Appearance and install size

mm							
DN (mm)	Max Working pressure (MPa)	L	D	K	n-øA	Compact type (kg)	Remote type (kg)
10	4.0	150	90	60	4-ø14	6	4
15		150	95	65	4-ø14	6	4
20		150	105	75	4-ø14	6	4
25		150	115	85	4-ø14	7	5
32		150	140	100	4-ø18	9	7
40		150	150	110	4-ø18	10	8
50		200	165	125	4-ø18	12	10
65		200	185	145	8-ø18	17	15
80		200	200	160	8-ø18	17	15
100	1.6	250	220	180	8-ø18	22	20
125		250	250	210	8-ø18	24	22
150		300	285	240	8-ø22	35	33
200	1.0	350	340	295	8-ø22	45	43
250		400	395	350	12-ø22	84	82
300		500	445	400	12-ø22	102	100
350		500	505	460	16-ø22	123	121
400		600	565	515	16-ø26	147	145
450		600	615	565	20-ø26	212	207
500		600	670	620	20-ø26	229	210
600		600	780	725	20-ø30	252	250
700		700	895	840	24-ø30	352	350
800		800	1015	950	24-ø33	462	460
900	900	1115	1050	28-ø33	558	550	
1000	0.6	1000	1235	1120	28-ø36	690	680
1200		1200	1405	1340	32-ø33	785	780
1400		1400	1630	1560	36-ø36	1258	1250

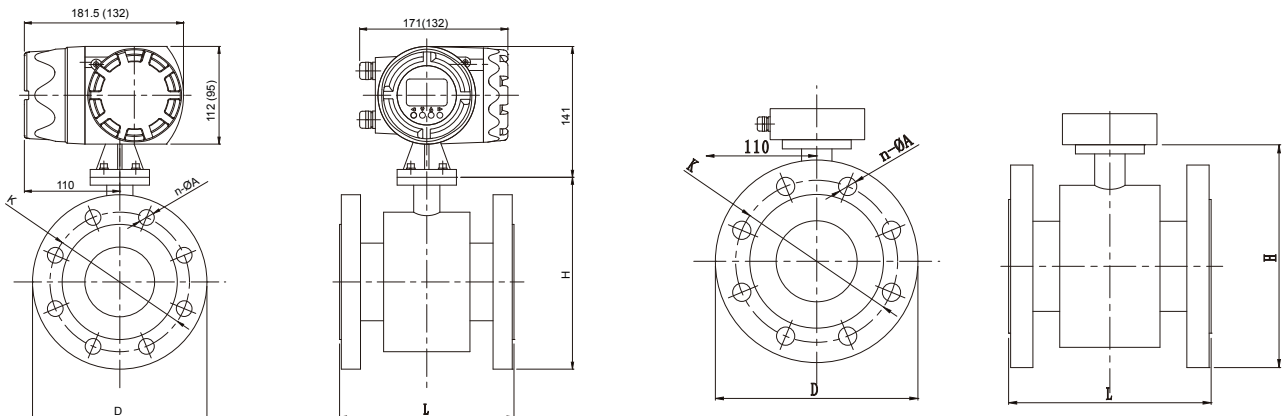

5. Specifications

1). Max flow range for EMF (Choice of reference map) :

DN	Common choice of full scale flow range (m ³ /h)
10	0.16, 0.2, 0.25, 0.3, 0.4, 0.5, 0.6, 0.8, 1.0, 1.2, 1.6, 2.0, 2.5
15	0.4, 0.5, 0.6, 0.8, 1.0, 1.2, 1.6, 2.0, 2.5, 3.0, 4.0, 5.0, 6.0
20	0.6, 0.8, 1.0, 1.2, 1.6, 2.0, 2.5, 3.0, 4.0, 5.0, 6.0, 8.0, 10.0, 12.0
25	1.0, 1.2, 1.6, 2.0, 2.5, 3.0, 4.0, 5.0, 6.0, 8.0, 10.0, 12.0, 14.0, 16.0
32	1.6, 2.0, 2.5, 3.0, 4.0, 5.0, 6.0, 8.0, 10.0, 12.0, 16.0, 20, 25
40	2.5, 3.0, 4.0, 5.0, 6.0, 8.0, 10.0, 12, 16, 20, 25, 30, 40
50	4.0, 5.0, 6.0, 8.0, 10, 12, 16, 20, 25, 30, 40, 50, 60, 70
65	6.0, 8.0, 10, 12, 16, 20, 25, 30, 40, 50, 60, 80, 100, 120
80	10, 12, 16, 20, 25, 30, 40, 50, 60, 80, 100, 120, 160
100	16, 20, 25, 30, 40, 50, 60, 80, 100, 120, 160, 200, 250
125	25, 30, 40, 50, 60, 80, 100, 120, 160, 200, 250, 300, 400
150	40, 50, 60, 80, 100, 120, 160, 200, 250, 300, 400, 500, 600
200	60, 80, 100, 120, 160, 200, 250, 300, 400, 500, 600, 800, 1000
250	100, 120, 160, 200, 250, 300, 400, 500, 600, 800, 1000, 1200, 1600
300	160, 200, 250, 300, 400, 500, 600, 800, 1000, 1200, 1600, 2000, 2500
350	200, 250, 300, 400, 500, 600, 800, 1000, 1200, 1600, 2000, 2500, 3000
400	250, 300, 400, 500, 600, 800, 1000, 1200, 1600, 2000, 2500, 3000, 4000
450	300, 400, 500, 600, 800, 1000, 1200, 1600, 2000, 2500, 3000, 4000, 5000
500	400, 500, 600, 800, 1000, 1200, 1600, 2000, 2500, 3000, 4000, 5000, 6000
600	600, 800, 1000, 1200, 1600, 2000, 2500, 3000, 4000, 5000, 6000, 10000
700	800, 1000, 1200, 1600, 2000, 2500, 3000, 4000, 5000, 6000, 10000, 12000
800	1000, 1200, 1600, 2000, 2500, 3000, 4000, 5000, 6000, 10000, 12000, 16000
900	1200, 1600, 2000, 2500, 3000, 4000, 5000, 6000, 8000, 10000, 12000, 16000
1000	1600, 2000, 2500, 3000, 4000, 5000, 6000, 10000, 12000, 16000, 20000
1200	2500, 3000, 4000, 5000, 6000, 8000, 10000, 12000, 16000, 20000, 25000, 30000
1400	3000, 4000, 5000, 6000, 8000, 10000, 12000, 16000, 20000, 25000, 30000, 40000

2.) Flowmeter curve graph of the relationship between Diameter, flow rate and flow

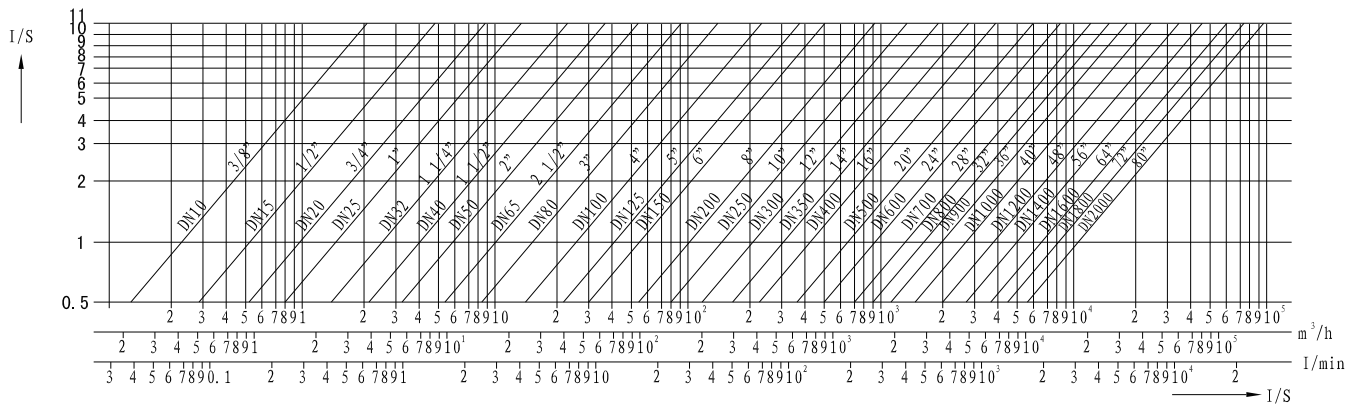

6. Installation

Electromagnetic flow sensor if not installed properly, will significantly affect measurement accuracy, even lead instrument not working properly, so Before installation instructions carefully read the relevant sections.

1.) Installation ways

Sensor installation method for the flange connection. Criteria and process pipe welding flange screw holes in the inter-position, bolt can be passed smoothly to facilitate the integration between the sensor and process piping.

Installation must ensure that sensors Center and the process pipe center line, and then a good grounding line, otherwise it would cause measurement error.

2.) The choice of installation environment

According to the work of instrument characteristics and technical characteristics, the choice of instrument installation environment should pay attention to:

- (1) The instrument should be installed at the ventilation to dry, avoid installing at the place easy accumulation water.
- (2) The instrument should try to avoid just sun shine and rain. Open-air installation, should keep out rain in places;
- (3) Installation of places as much as possible to avoid strong vibration;
- (4) as far as possible to avoid a strong electromagnetic field equipment; such as large motors, large transformers.
- (5) Select the ease of maintenance, activities, convenient place.

3.) The choice of installation location

Installed on the sensor in the pipeline, we should note the following points

- (1) sign the direction of the flow sensors and pipeline flows in the same direction within the medium;
- (2) The need to ensure that sensor tube is full filled with the measured medium;
- (3) The sensors should be five times the upstream straight pipe section D above, the sensor should be three times the downstream straight pipe section D above (available from the center of sensor , D to measure the pipe diameter);

4.) When the pipe diameter is inconsistent with the sensor, the sensor is installed at both ends tapered or gradually expanding tube, and then with the pipe connection. Gradually expanding, tapered conical tube should be no more than 15 degrees. When using 15 cone angle gradually expanding, tapered tube, the pressure loss resulting from the curve in Figure 4 :



图3

d.Sensor internal diameter; D.diameter, V.flow rate of sensor(m/s)

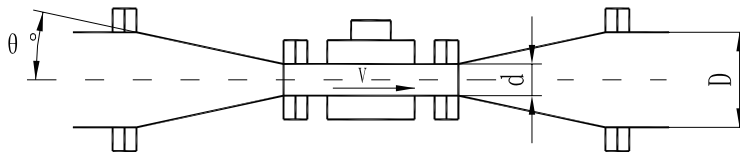
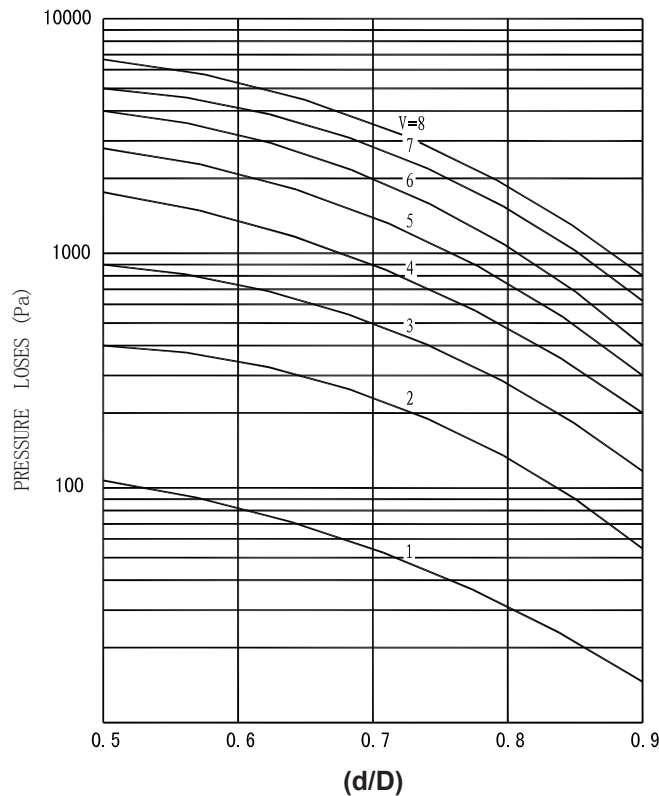

picture 4 Install reducing pipe or gradually expanding tub to effect pressure loss

5) sensor installation should be taken in the horizontal electrode as horizontal position, once the media containing bubbles or sediment, the bubbles will not be adsorbed on the electrode in the vicinity, resulting in conversion of the input terminal open circuit; sediment will not cover the electrode, caused by zero drift;

(6) liquid-solid two-phase medium, the vertical installation of a more favorable, a measured medium can prevent phase separation, two lining wear sensor allows more uniform. Vertical installation, the medium flow direction should be bottom-up, so as to ensure that the sensor tube is always filled with medium.

7. Installation position of sensor

In order to enable reliable flow meter, Pls note the following installation requirements:

1. As far as possible to avoid ferromagnetic objects and equipment with strong magnetic fields (big electric machine, big transformer) is protecting of the magnetic field sensor.
2. Flow meter should be enough space around for easy installation and Maintenance.

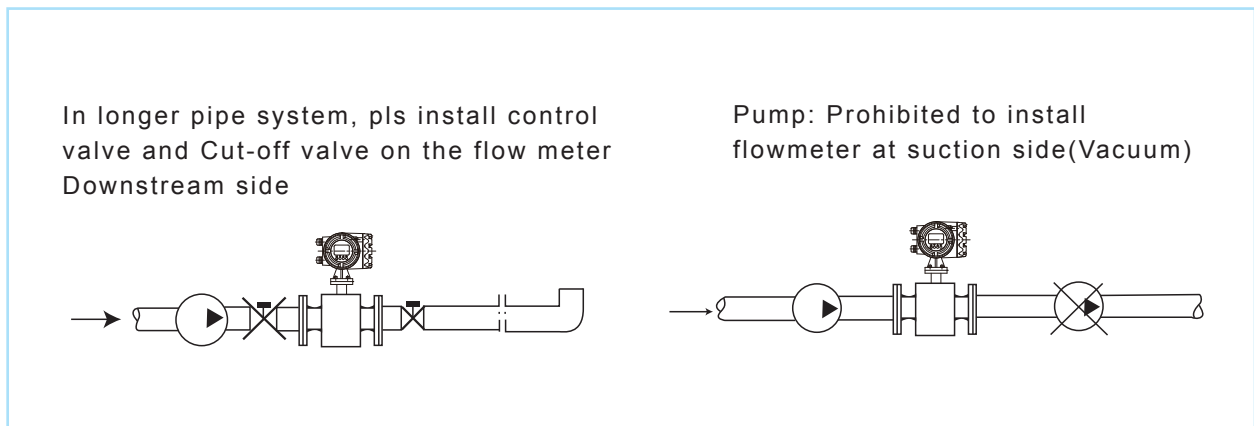
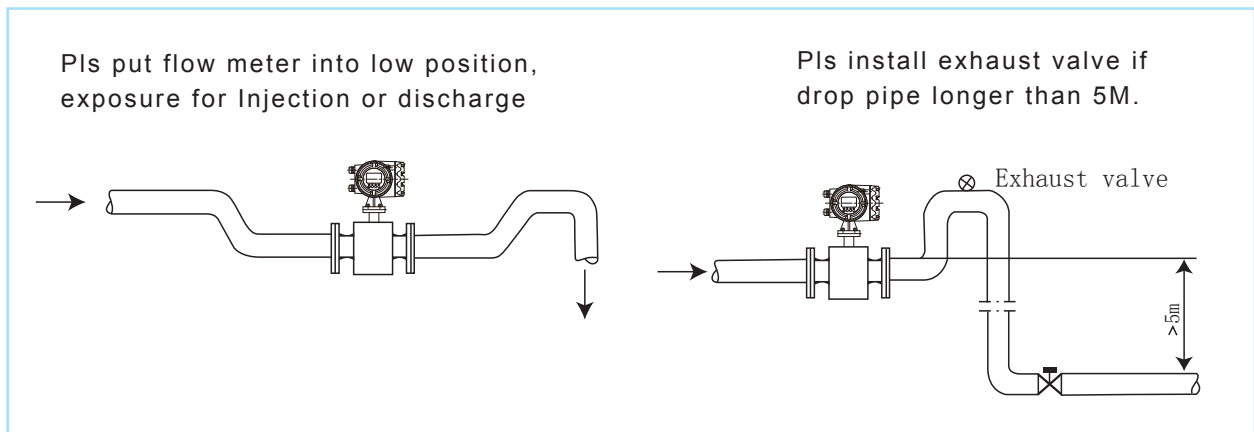
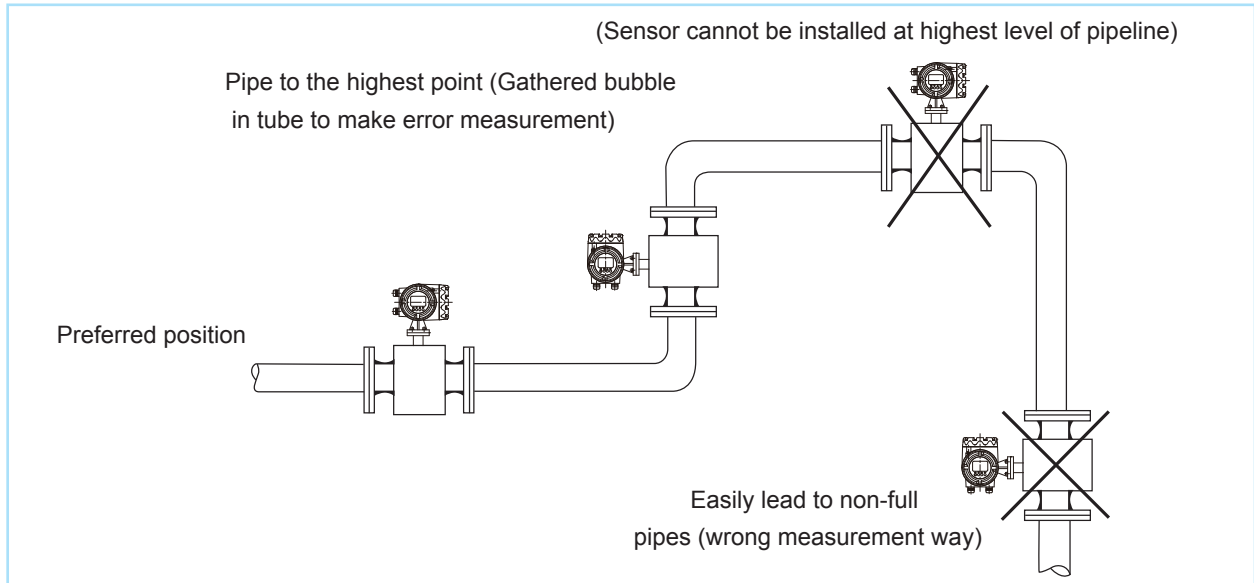

picture 5 recommend installation

8. Connecting cable

BOM 1 -Connecting cable

Items	Name	specifications	Qua.	Remarks
1	Signal lines	PVC sheathed 2 core shielded cable 2X16/015 (SBWP)	8 or 15m	Accessory kit
		PVC sheathed 2 core shielded cable 2X80/015 RWP		
		Ship sealed with rubber insulated cable 2X0.5		
2	Excitation wire	Two core plastic cable 2X1.0mm ² (YHZ)	8 or 15m	Accessory kit
		Marine soft ethylene-propylene rubber insulated cable 2X1.0(CEFR-C)		
3	Output signal lines	General Color plastic double-stranded copper wire		provided by users

9. Grounding

The flow sensor generated signal by is very small, when in full-scale only a few mV, so the sensor should be well grounded, in a good grounding line access must be in accordance with the ninth Page shown

Grounding requirements of the electromagnetic flowmeter has two aspects:

- 1) From the working principle of electromagnetic flowmeter and flow sensor signals to the circuit analysis, sensors and ground-side converter must be consistent with the measured medium equipotential.
- 2) Grounding to the earth is zero potential to reduce outside interference. Under normal circumstances, industrial pipes are metal tubes and grounded in itself, which easily meet the requirements, but in a larger external electromagnetic field interference, the electromagnetic flowmeter grounding devices should be set up for other way, with grounding line is greater than the total cross-section 6mm 'multi-strand copper wire, the grounding line of sensors cannot be received in the motor or other equipment to the public online in order to avoid the effects of leakage current. Grounding resistance should be less than 10.
- 3) Sensor is installed in the plastic pipe lines or in the pipe insulation, the sensor should be installed at both ends of the grounding ring or grounding flange, or with a ground electrode a short tube, shown in figure 7.
- 4) Sensor be installed on the Catholic protection of pipelines, it must be installed two ends of grounding ring (or grounding flange) on the sensors. Figure 8

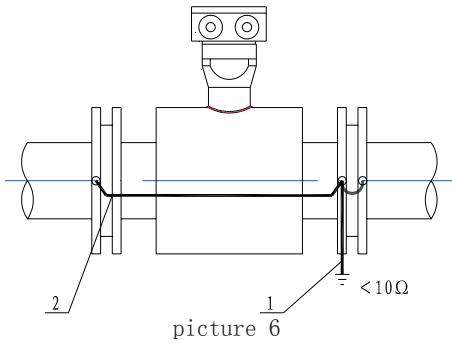

Sensors installed in the metal pipe of grounding diagram

- 1, grounding line (outside interference device larger installation)
- 2, Flowmeter grounding line (with factory)

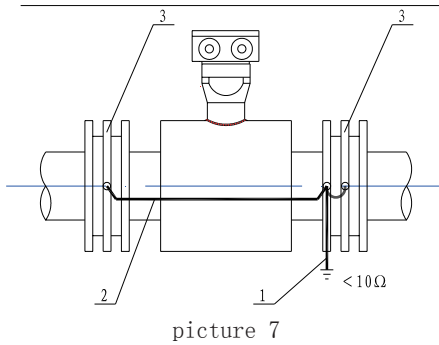

Plastic pipe or pipe insulation lining grounding diagram

- 1, grounding line (outside interference device larger installation)
- 2, Flowmeter grounding line (with factory)
- 3, grounding or earthing ring flange

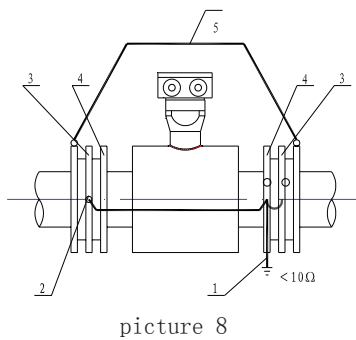

Pipeline cathodic protection installed for the grounding diagram

- 1, grounding device line (outside interference larger installation)
- 2, flowmeter grounding line (with the factory);
- 3, grounding or earthing ring flange must be consistent with the flange connecting pipe insulation
- 4, bolts (installed with the flange should be mutual insulation)
- 5, connecting wire, copper cross-sectional area of 16mm. So that piping and cathodic protection isolate between the sensor.

10. The preparation of pre-operational

Important Note: the whole instrumentation (including sensors and Transmitter) to run a rigorous adjustment and flow calibration in the factory, one by one after passing the test

In Plants. To the end user, So, it can be put into operation without any adjustments. Therefore, the initial operation of the problems encountered, should be in accordance with the specifications Reference points one by one inspection, a careful analysis, troubleshooting. Avoid Blindly tamper to make a good set of adjustments to the original instrument to confuse or even damage.

Instrument can be put into operation the following steps:

- 1) First open upstream and downstream the valve with Sensor, so that sensors measuring tube filled with test medium;
2.) Power for one minute, Transmitter showed an immediate increase to a certain numerical value, pls wiring is correct or not, when the flow direction is wrong,pls Check the direction of the sensor installation is correct.
- 3) zero Trim , instrument through the media 15 minutes after the first sensor tightly closed valve downstream side, and then shut down the upstream side of the valve, so that tube Stop the flow of fluid and no leakage, the flow shows zero. Zero if too high or too low, Pls do Zero Trim on the Transmitter.

Specific operations see Transmitter Manual p. 27

11. Common failures and how to deal with

Electromagnetic flow sensors generally do not require regular maintenance, but medium of measured is easily adhesion in the electrode or dielectric tube wall measurements or scaling of the occasion, the need for regular cleaning pipe wall of measurement and electrodes, attention do not damage liner, electrode.

Failure to deal with reference to Table

Regular failure and obviate method

Troubles	Possible Causes	Check the troubleshooting
Liquid flow through the meter without instructions	1. Moisture sensor or signal-to-ground short-circuit resulting in damage	Use a multimeter to check insulator of signal line whether good or not
	2. Signal circuit break	Use a multimeter to check signal good or not
	3. Open-loop excitation	Use a multimeter to check sensor loop is good or not
	4. Transmitter failure	According transmitter manual inspection, troubleshooting
Changes in the flow apparatus showed that full-scale on transmitter	1. A signal-to-ground short-circuit or open circuit	Check signal line to ground resistance to use a multimeter measuring electrode-to-ground resistance, generally from thousands of OM to some 10k om
	2. Medium in tube not full	Use a multimeter to check signal lines open or not and to improve the installation method
	3. Imperfect earth	Check the signal shielding layer and then place resistors, re-installation of grounding devices
Instrumented inconsistent with the actual flow	1. Change the zero point to make measurement error	Grounding bad or electrode dirty, Zero Trim after inspections
	2. Transmitter configure be modified	Adjusted in accordance with the parameters set, and then zero trim
	3. Medium in tube not full	Inspection process to improve the installation method
	4. Electrode or wall scaling	Clear scaling
	5. Error in actual determination to check with Flowmeter	Carried out using standard flow meter to compare

12. Open box and product sets

Check packing box, and check the sensor model, the contract specifications in line with the order randomized complete documents

packing list	1 pcs
KF700 series EMF manual instructions	1 pcs
certification	1 pcs
CD	1 pcs

13. Quality Assurance

Instruments and accessories from the factory from the date of 12 months, when a user products in full compliance with the technical requirements and installation instructions provided in the transport, installation and use of the provisions of instruments and accessories have found products that do not meet technical standards, the instrument may be returned factory, this factory is responsible for free repair.

14. Transport and storage

Instruments to prevent damage in transit, on arrival at the scene after the installation, please keep the state at the time of factory shipment, storage location of the indoor conditions on the follow:

- a) ventilation, rain, moisture, indoor air should not contain the harmful effects of corrosive substances;
- b) a small mechanical vibrations and to avoid the impact;
- c) temperature range in $-20^{\circ}\text{C} \sim +60^{\circ}\text{C}$
- d) do not dry 90% humidity

15. Order Information

Orders must be measured in accordance with specific targets and measuring conditions of access to the Company on the selection of technical information and ordering the right choice. E.

According to the actual situation, the order should be determined:

- 1) the scope of the model and flow measurement. Order to determine, based on sensor diameter models. Full-scale instrumentation (ie, range) should not be less than the actual measured flow of the largest pipeline, and the normal flow of more than 50% of the selected range in order to obtain high precision.
- 2) pressure meter, temperature must meet the test medium pressure and temperature.
- 3) come into contact with the measured medium liner, electrode corrosion media should be capability measured. Therefore, users must be ordered according to their own experience of anti-corrosion,

Refer to the company's existing varieties of lining and electrode materials (see 12th page), the correct selection of materials.

- 4) the need for installation with matching flanges, please specify when ordering.

16. Instrument serial number and model matching

- (1) sensor ID
- (2) sensor coefficient
- (3) Converter Model
- (4) other

17. Common electrode materials corrosion performance

Material	Corrosion performance
Acid-resistant steel 1Cr18Ni9Ti	To nitric acid, phosphoric acid and other cold inorganic acid, a variety of salt and alkali solutions, organic acids, water-resistant for a good corrosion resistance. Formic acid of boiling, Oxalic acid, industrial acid-ming, as well as sodium carbonate and chlorine, bromine, iodine, such as poor chemical stability of medium, not corrosion.
Stainless steel containing molybdenum 0Cr18Ni12Mo2Ti 0Cr18Ni12Mo3Ti	In the reductive medium (such as hydrochloric acid) compare with 1Cr18Ni9Ti have stronger corrosion resistance. Less than 50% of the nitric acid, at room temperature less than 50% of sulfuric acid and 20% of the hydrochloric acid, alkali solution, boiling phosphoric acid, formic acid, under pressure from a certain sub-sulfuric acid, water, acetic acid and other media have a strong corrosion resistance, can be widely used in petrochemical, urea, vinylon industry. Intolerant of hydrofluoric acid, chlorine, bromine, iodine and other medium.
HastelloyB	Below Boiling point of all of the following concentrations of hydrochloric acid with good corrosion resistance, is also resistant to sulfuric acid, phosphoric acid, hydrofluoric acid, organic acids and other non-oxidizing acids, alkalis, salt solution of non-oxidative corrosion.
HastelloyC	Oxidation of acid-resistant, such as nitric acid, mixed acid or chromic acid and sulfuric acid corrosion of mixed medium, but also resistant to oxidation of the salts such as Fe ²⁺ , Cu ²⁺ corrosion or other oxidants. Such as higher than normal temperature of the hypochlorite solution. Seawater corrosion resistance is very good
Ti	Medium resistance of oxygen and nitric acid, chloride, hypochlorite and chlorine the corrosion resistance of a good medium.

18. Common properties of lining materials and application.

Lining material	The main performance	Application temperature	The main performance
PTFE	It is the most stable plastic material. Ability to boiling Of hydrochloric acid, sulfuric acid, nitric acid and aqua regia, but also strong capability Alkali, organic agent. Molten alkali metals and intolerance, Its ammonia solution, abrasion resistance and poor bonding	-80~250°C	Has an excellent wear resistance, which is equivalent to the pressure of natural rubber pipe measurement acids, alkalis, Like salt, strong corrosive medium or medium health category.
Chloroprene rubber	Have good flexibility, high tensile strength, abrasion resistance, good impact resistance. Acid, alkali, salt and other corrosive media. Intolerance oxidative corrosion media	0~80°C	A non-oxidizing acids, alkalis, salt solution.
Polyurethane Rubber	Has an excellent wear resistance, which is equivalent to ten times that of natural rubber.	0~60°C	Oil drilling, slurry, mud, Mortar serious occasions, such as wear and tear

System instructions



Transmitter's configuration in accordance with the contract requirements, run the data set in accordance with contract requirements. Users can check the meter nameplate to confirm that the instrument provided by the model and instrument operating parameters set. It can be put into use after connect power. In order to ensure your system run on normal operation, make sure that the sensor measurement is full of medium channels

Our company electromagnetic flowmeter is dedicated to conductive fluid (conductivity $\geq 5\mu\text{S}/\text{cm}$, water $\geq 20\mu\text{S} / \text{cm}$) the volume of flow measurement.

Flowmeter installation and usage should be in strict accordance with the specification, and to comply with the relevant national standards, safety requirements and accident prevention requirements.

MF7200 electromagnetic flow converter directly connected with the electromagnetic flow sensor compact into one body

I . Installation

1. Working condition

- | | |
|---|--|
| <p>1.) The working conditions of the reference test:</p> <ul style="list-style-type: none"> a) operating temperature: $20^{\circ}\text{C} \pm 2^{\circ}\text{C}$ b) relative humidity: 45% ~ 85% c) the supply voltage: $220\text{VAC} \pm 2\%$ d) Power frequency: $50\text{Hz} \pm 5\%$ e) harmonic content: $< 5\%$ f) warm-up time: $> 15\text{min}$ | <p>2) The working conditions: :</p> <ul style="list-style-type: none"> a) ambient temperature: $-20^{\circ}\text{C} \sim 55^{\circ}\text{C}$ b) relative humidity: 5% -90% c) power supply AC Power Supply: $85\text{VAC} \sim 265\text{VAC}$, 50Hz DC Power Supply: $18\text{VDC} \sim 36\text{VDC}$ Rated Power: $< 10\text{VA}$ (include sensor) |
|---|--|

2. Installation Notes

1.) Environment temperature

It should avoid large temperature changes. If the meter installed by the thermal radiation Plateau, please provide the thermal isolation or ventilation. Instrumentation installed in the switch box, there should be appropriate measures of net and ventilation are examples such as the fan. Compact structure flow meter should give full consideration to the transmitter working environment temperature.

2.) Installation environment

It should avoid in a strong corrosive atmospheric environment. Installation location should have adequate ventilation. Protective properties of instruments should be maintained to prevent the corrosive gases and moisture into the instrument cavity. It Should avoid direct sunlight, especially the liquid crystal display part. Strong vibration should be avoided.

3.) Installation methods

A compact body flowmeter transmitter and Sensor two parts is connected to the end before out of factory, the user can be installed directly. Sub-constructer flowmeter for Transmitter and sensors to be in two parts at field by the user through a dedicated cable (factory annex) to connect. Part of the sensors installed on both glycosides, Transmitter are usually installed in the indoor or meter box. The distance is shorter for better.

II. Power line connecting



Instrumentation and electrical installation work must be connected by a certain qualified staff to implement. Be sure to operate before reading this operation manual carefully to avoid wrong operation caused by solid work instrument error or damage. Converter must have a good grounding in order to protect their personal safety. Use in hazardous area must be provided by columns according to special "EX" in the operating manual instructions. Instrument should be in the electrical connection before power run.

Operation principle and requirements :

1. The lid of Instrument just open in the wiring, once opening the lid of instrument will affect protection performance. It should be back to the factory sealed lid state after the wiring finished.
2. In order to ensure the insulation of instrument performance, to prevent the instrument as a result of wet insulation caused by poor rains ,in the outdoor wiring should be avoided.
3. with a threading instrument connectors, cable connectors must be approved by threading into the instrument cavity (see circle). After the wiring , waterproof joints should be tightened to ensure that moisture and corrosive gases do not enter the electronic part.

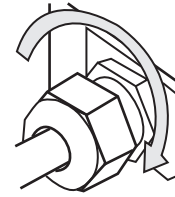

4. Input and output lines recommend the use of the installation of conduit, conduit tube be recommended thick solid brass or soft metal pipes Road. Conduit should be noted that the order to prevent flood water flowing into the conduit or conduit into the internal instrumentation. Input power line and signal lines should be separated through their respective special perforated cavity into the instrument, prohibited parallel and banding together.
5. The choice of input and output cables to reference the following description:
 Excitation, a dedicated flow meter signal cable is provided by our company.
 Power Line: owned by the user, customer can option YH Z-2x1mm2 two soft-core rubber insulated cable, cable length should concern voltage drop.
 Output line: owned by the user, customer can option RVVP2X16 / 0 15 PVC insulated sheathed wire shielding, cable length will affect the load characteristics.

1. Instrument Power supply

This series of transmitter have the following power supply types.

- 1) AC Power supply range
85VAC-265VAC, 50Hz power ~ 10VA (including sensors)
- 2) DC power supply range
18VDC 36VDC; power ≤ 10W (including sensors)



Before connecting the power supply, please see the nameplate and part of the electrical terminals and the types of instructions ,in order to avoid misoperation to make instrument error or damage

2. Power line connecting

Operation steps:

- 1, open the rear cover of the transmitter
- 2, a dedicated power supply input line threading through the hole (Waterproof connector) into the instrument cavity.
- 3, the grounding wire connected to the transmitter side of the ground.
- 4, AC (AC) power lines L and N lines were connected to the converter side of the L and N-side.
 Direct current (DC) power supply to power + lines and - receiving line side converter, respectively, the + terminal and - terminal.
- 5, water-proof connector threading screw instrumentation and to return to the status of the factory sealed.

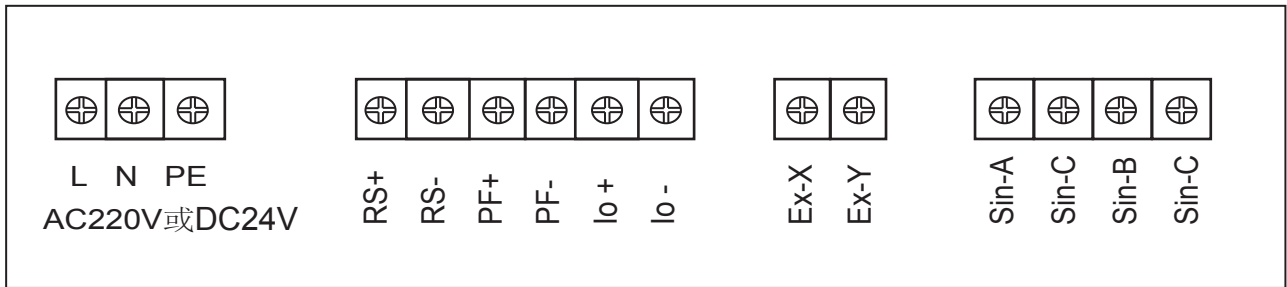

Diagram of output signal terminal
Terminal Description

Identifier	Functional	Description
L	220VAC Power, L terminal	Power range: 85 VAC-265VAC、50Hz
N	220VAC Power, Nterminal	
+	24 VDC Power, positive terminal	Power range: 18 VDC -36VDC
-	24 VDC Power, negative terminal	
	Power Ground terminal	Grounding resistance <= 10 Ω

Description :

Pay attention to the following questions on connect the power supply :

- 1, the power cable of inside the sensor will not wound.
- 2, the power input line should separated with other input and output lines , threading through the holes into their own dedicated instrument cavity.
- 3, noted that the positive and negative polarity DC power supply, if the reverse then the instrument does not work.
- 4, power supply should have a good grounding in order to protect the operator's personal safety.

3. Output signal

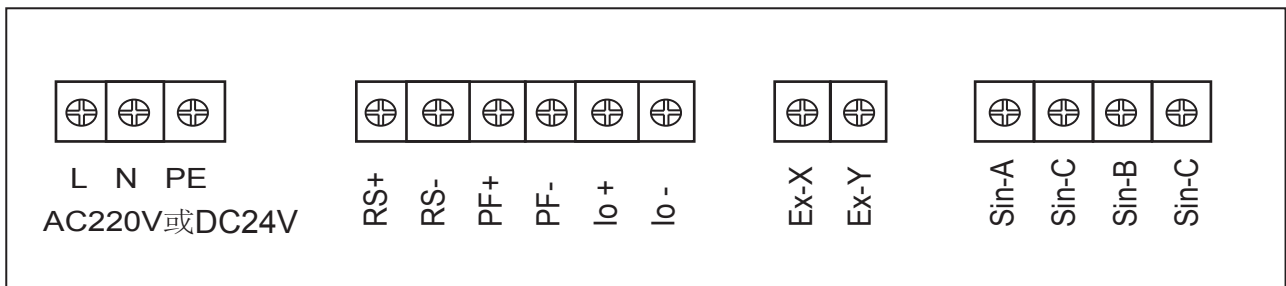
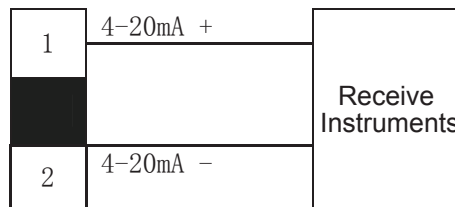

Diagram of output signal terminal
Terminal Description

Terminal description

Items	Lable	Function Instructions	Remarks
1	4-20mA +	4-20mA Output positive terminal	1, Load resistance:750Q (with link) 2, Hart Communications external 24VDC power supply Active Output Mode
2	4-20mA -	4-20mA Output negative terminal	
3	0~2KHz+	Frequency/pulse output positive terminal	The output amplitude of 24V load current <=50mA
4	0~2KHz-	Frequency/pulse output negative terminal	
5	RS485date+	RS485 Communication positiveterminal	RS485 communication function (n just for transmitter has this function
6	RS485date -	RS485 Communication negativeterminal	

1.) Electric current output



The converter current output electrical isolation has been achieved. Output to take an active approach. Current output mode 4-20mA, 20mA current output value from the corresponding traffic parameter item "scale flow of value" is determined (reference to factory nameplate on the instrument measuring range a value). The maximum current output load resistance of 750Q, the load resistance includes the cables used to connect the resistance. Current output cable is recommended RWP2x16/015 PVC insulated sheathed cable shield. 2.

2.) Pulse, frequency output

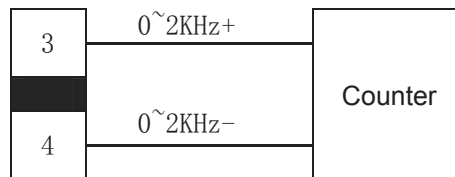

The Transmitter frequency, pulse output has been achieved electrical isolation, the output for the active mode (see above chart). Transmitter frequency, pulse output with transistor output mode. Maximum pulse output frequency 5KHZ, the output pulse amplitude of 24V. Active mode the maximum load current 50mA, passive mode the maximum load current 0.2A. As the frequency and pulse output terminals are shared, it is not to choice two output modes. Users can set the parameter "frequency output" to select the work. Frequency output upper limit corresponding to the measured flow value by the parameter item "scale flow value" decision (reference instruments to measure the scope of a factory nameplate values). Pulse output equivalent by the parameter 'pulse equivalent L / P "decision.

3.) Function of communication

Transmitter communication with RS485, MODBUSASC, MODBUSRTU communications capabilities (requires a user specified when ordering). Available through the "485 output communication protocol" parameter is set to specify. Instrument Communication Interface specific technical note on "protocol."

III. Instrument started



Before connect power, follow the manual of the first part of the note 1,2 and sensor part of the installation manual to verify whether the system is properly installed and connections. End customer can directly run instrument, the reason is including sensors and signal transmitter of two parts, all of the data have been based on user requirements and technical specifications of the company's manufacturing process in the factory setting.

1 .Working instrument showing

After complete correct electric connection, run power on instrument. Instrument transmitter first implementation of the initialization; display the company logo (see below). Wait 3 seconds after the instrument into the own measurement mode, immediately began to flow measurement and displays the current flow measurement value or other self-assemblies off information. If there is no meter to power after the show (display without backlight), then the power supply and connectivity in identifying ways to meet the requirements, may view the instrument power supply fuse is intact (you can see the 8 common faults and processing).



If there is no meter to power after the show (display without backlight), then the power supply and connectivity in identifying ways to meet the requirements, may view the instrument power supply fuse is intact (you can see the 8 common faults and processing).

2 . Interface show

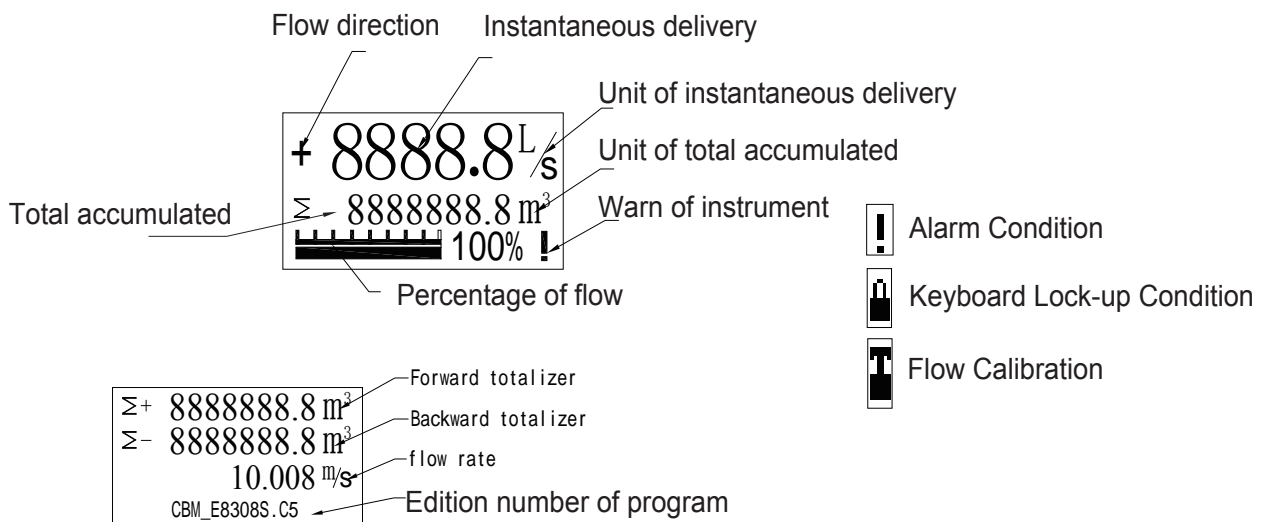

Flow Auxiliary Interface

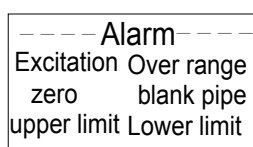

Alarm Interface

Instructions:

Instrument Display Interface

1. The first line shows an instantaneous flow rate, flow rate display units can be in the 'flow unit' function key to choose;
2. The second line shows the percentage of traffic and flow units
3. The third line shows the cumulative total amount
4. The fourth line shows the total cumulative and cumulative units
5. fifth line shows the warning prompt and projects
6. sixth line shows the program version number

3. Power Supply Fuse Replacement



Replace the fuse should have a certain professional competence of people to perform. if the meter to replace the fuse still would be no show, then please contact the manufacturer.

IV. Operations

1 . Panel construction and key definition

1.) MF710 、 730 series

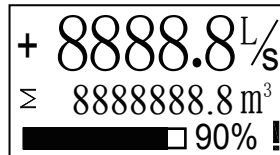

2.) Function instructions





- parameter confirmation and withdraw from subprogram
- Set item (the key of downward and decrease of data variable)
- set item (the key of move to right)





short key and multiple key

- & system for short set "ZERO", press and then press

2. menu construction

Mode of Measure Press 	Configuration Menu press 	Parameter item Press 	Secondary Parameter item 			
1. BASIC	1.1 PV Units 1.2 PV Decimal 1.3 Total Units 1.4 Total Decimal 1.5 Damping(s)					
				2. SYSTEM	2.1 Signal	2.1.1 Qmax(m ³ /h) 2.1.2 Low Cutoff % 2.1.3 Max Limit% 2.1.4 Limit Time(S) 2.1.5 Direction 2.1.6 Indication
					2.2 Pulse Output	2.2.1 Freq Max(Hz) 2.2.2 Liter/pulse 2.2.3 Pulsewidth(ms)
					2.3 MODBUS Output	2.3.1 Protocol 2.3.2 Baudrate 2.3.3 Parity 2.3.4 Dev Address
					2.4 Clear Total	
	2.5 Load Settings					
	3. Calibration	3.1 Tube Trim	3.1.1 Empty Trim 3.1.2 Full Trim 3.1.3 TubeRegion%			
		3.2 Loop Trin	3.2.1 4mA Trim 3.2.2 20mA Trim			
		3.3 Zero Trim				
		3.4 K Character				
3.5 Total preset						
3.6 Manual Adjust		3.6.1 Actual Zero(mV) 3.6.2 Empty Freq(Hz) 3.6.3 Full Freq(Hz)				
4. Test	4.1 Loop Test					
	4.2 Pulse Test					

mode of measure press 

configuration menu press 

parameter item press 

secondary parameter item Press 

3. Select menu item Measurement mode

Enter the parameter setting Press "C / CE "bond. Appears in Figure interface, select" C / CE "will enter the menu:

- (BAS) Basic Configuration
 - (SYS) System Configuration
 - (TRIM) Instrument Calibration
 - (CHK) Instrument Test
- Click"→" to quit menu

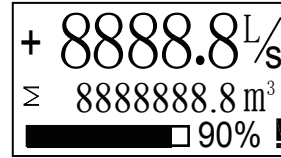

(BAS)Basic Configuration PV Units PV Decimal Total Units Total Decimal Damping(s)	<div style="border: 1px solid black; padding: 5px;"> PV Units → PV Decimal → Total Units → Total Decimal → </div>
--	--

(SYS)System Configuration Language Signal Pulse Output MODBUS Output Total Set Load Settings	<div style="border: 1px solid black; padding: 5px;"> Language Signal → Pulse Output → MODBUS Output → </div>
--	---

(TRIM) Instrument Calibration Tube Trim Loop Trin Zero Trim K Character Manual Adjust	<div style="border: 1px solid black; padding: 5px;"> Zero Trim Tube Trim → Loop Trim → K Character </div>
--	--

(CHK)Instrument Test Loop Test Pulse Test	<div style="border: 1px solid black; padding: 5px;"> Loop Test Pulse Test </div>
---	---

4. Operation Guide for regular function of Transmitter

1.) Zero Trim

In order to obtain accurate measurement results, the electromagnetic Flowmeter should be zero Trim before re-installation. This series of transmitter has two calibration methods, the user can choose one way to Zero calibration.



Before Zero Trim the instrument; flowmeter measuring tube filled with medium, and in a quiescent state. Flowmeter be good grounded (see page 9). Meter Warm-up time of not less than 15 minutes.

Steps:

measurement mode → Calibration → Zero Trim

Steps	Operation instructions	Interface show
1	Click “▶” key, enter “Zero Trim”	<div style="border: 1px solid black; padding: 5px; width: fit-content;"> Zero Trim No No </div>
2	Click “▼” key to change “No” to “Yes”	<div style="border: 1px solid black; padding: 5px; width: fit-content;"> Zero Trim No Yes </div>
3	Click “◀” to show confirm menu	<div style="border: 1px solid black; padding: 5px; width: fit-content;"> Zero Trim No <-ENT ESC-> Yes </div>
4	Click “◀” again to run “zero trim”, if click “▶”, quit “zero trim” stage	<div style="border: 1px solid black; padding: 5px; width: fit-content;"> Zero Trim <-Yes No-> </div>
5	waiting “Zero trim” finish and automatically return Trim menu. Click “◀” two times back to measurement mode	

2.) Unit of flow

Adjust instant flow's unit, the setting rang L/S, L/min, L/h, m³/S, m³/m, m³/h, gal/S, gal/m, gal/h

Steps:

measurement mode → Basic → PV Units

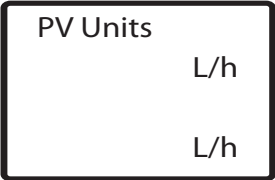
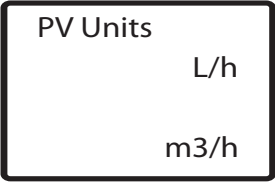
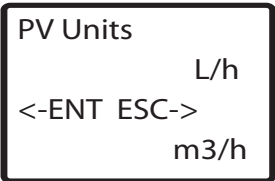
Steps	Operation instructions	Interface show
1	Click "▶" key, enter "PV Units "	
2	Click "▼" key to change Unit of flow, Click "◀" to show confirm menu	
3	Click "◀" to confirm, Click "▶" give up modify.	
4	Click "◀" two times from configuration menu to measurement menu, also you can continue other operation.	

3.) Instantaneous flow Resolution

Adjust the instantaneous flow of small points indicate the medium, set the range of 1-3 decimal places

Steps:

measurement mode → Basic → PV Decimal

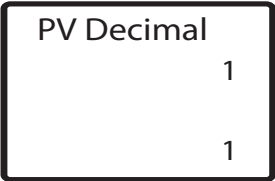
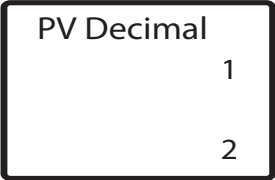
Steps	Operation instructions	Interface show
1	Click "▶" key, enter "PV Decimal "	
2	Click "▼" key to change Instantaneous flow Resolution, Click "◀" to show confirm menu	

Steps	Operation instructions	Interface show
3	Click “◀” to confirm , Click “▶” give up modify.	<div style="border: 1px solid black; padding: 5px; width: fit-content;"> PV Decimal 1 <-ENT ESC-> 2 </div>
4	Click “◀” two times from configuration menu to measurement menu, also you can continue other operation.	

4.) Unit of Total

Adjust Total unit, setting range L,m³,gal

Steps:

measurement mode→Basic→ Total Units

Steps	Operation instructions	Interface show
1	Click “▶” key, enter “Total Units	<div style="border: 1px solid black; padding: 5px; width: fit-content;"> Total Units L L </div>
2	Click “▼” key to change Unit of Total,Click “◀” to show confirm menu	<div style="border: 1px solid black; padding: 5px; width: fit-content;"> Total Units L m3 </div>
3	Click “◀” to confirm , Click “▶” give up modify.	<div style="border: 1px solid black; padding: 5px; width: fit-content;"> Total Units L <-ENT ESC-> m3 </div>
4	Click “◀” two times from configuration menu to measurement menu, also you can continue other operation.	

5.) Cumulative total flow resolution

Adjusted cumulative flow dots show the median, set the range of 1-3 decimal places

Steps:

measurement mode→Basic→ Total Decimal

Steps	Operation instructions	Interface show
1	Click “▶” key, enter “Total Decimal ”	<div style="border: 1px solid black; padding: 5px;"> Total Decimal 1 1 </div>
2	Click “▼” key to change Cumulative total flow resolution Click “◀” to show confirm menu	<div style="border: 1px solid black; padding: 5px;"> TotalDecimal 1 2 </div>
3	Click “◀” to confirm , Click “▶” give up modify.	<div style="border: 1px solid black; padding: 5px;"> TotalDecimal 1 <-ENT ESC-> 2 </div>
4	Click “◀” two times from configuration menu to measurement menu, also you can continue other operation.	

6.) Damping time

Damping time on the meter display and output. Set range o 1-99 9S (unit is "seconds"). Set as follows:

Steps:

measurement mode→Basic→ Damping

Steps	Operation instructions	Interface show
1	Click “▶” into “damping”	<div style="border: 1px solid black; padding: 5px;"> damping(S) 01.0 Max: 99.9 Min: 0.1 0.10 </div>
2	Click “▲” and “▶” key to set “Damping”, Click “◀” show confirm menu	<div style="border: 1px solid black; padding: 5px;"> damping(S) 01.0 Max: 99.9 Min: 0.1 03.0 </div>
3	Click “◀” key to confirm and return configuration menu(click”▶” give up modify	<div style="border: 1px solid black; padding: 5px;"> damping(S) 01.0 <-ENT ESC-> 03.0 </div>
4	Click “◀” two times from configuration menu to measurement menu, also you can continue other operation.	

7.) Scale flow m³/h

Meter-scale flow (QMAX) range depending on the caliber meter (DN, unit :mm). Scale flow units: m³/h.

$Q_{min} = DN^2 / 3540$ (the equivalent of the current caliber(0.1m/s velocity)

$Q_{max} = DN^2 / 29.5$ (equivalent diameter 12m/s velocity)

The scale value of the flow meter relate output and frequency output :

Current output Iout : Instruments measured value / scale flow settings x16 +4

Frequency output Fout: Instruments measured value / scale flow settings values x the frequency maximum rate settings

Damping time on the meter display and output. Set range o 1-99 9S (unit is "seconds"). Set as follows:

Steps:

measurement mode → system → signal → Qmax(m³/h)

Steps	Operation instructions	Interface show
1	Click "▶" into "Qmax(m ³ /h)"	<div style="border: 1px solid black; padding: 5px; width: fit-content;"> Qmax(m³/h) 100mm 100.0 Max: 424 Min: 5.65 100.0 </div>
2	Click "▲" and "▶" key to set "Qmax(m ³ /h)", Click "◀" show confirm menu	<div style="border: 1px solid black; padding: 5px; width: fit-content;"> Qmax(m³/h) 100mm 100.0 Max: 424 Min: 5.65 200.0 </div>
3	Click "◀" key to confirm and return configuration menu(click "▶" give up modify	<div style="border: 1px solid black; padding: 5px; width: fit-content;"> Qmax(m³/h) 100.0 <-ENT ESC-> 200.0 </div>
4	Click "◀" three times from configuration menu to measurement menu, also you can continue other operation.	



To change the parameter will lead to the meter output value mutation, if posterior instrumentation, then modify this parameter should be considered before install posterior instrumentation(if need it).

Posterior instrumentation-related operational requirement

8.) Small flow termination%(low %)

The parameters on the display and output are valid. When the traffic signal to terminate below the low flow rate (unit%) of the settings to set the value of the The signal will be removed, display and output to zero. The termination of the small percentage is relative to the scale in terms of flow rate settings. Set As follows

Steps:

measurement mode→system→ signal→Low Cutoff%

Steps	Operation instructions	Interface show
1	Click “▶” into “Low Cutoff%”	<div style="border: 1px solid black; padding: 5px;"> Low Cutoff% 1.0 Max: 9.9 Min: 0.0 1.0 </div>
2	Click “▲” and “▶”key to set “Low Cutoff%”,Click “◀” show confirm menu	<div style="border: 1px solid black; padding: 5px;"> Low Cutoff% 1.0 Max: 9.9 Min: 0.0 2.0 </div>
3	Click “◀” key to confirm and return configuration menu(click”▶” give up modify	<div style="border: 1px solid black; padding: 5px;"> Low Cutoff% 1.0 <-ENT ESC-> 2.0 </div>
4	Click “◀” three times from configuration menu to measurement menu, also you can continue other operation.	

9.) Frequency upper limit Hz

output frequency range of the instrument 100-5000Hz

Scale corresponding to the current flow of output frequency

$$\text{Output frequency (Hz)} = \frac{\text{the current flow rate (m3/h)}}{\text{scale flow rate (m3/h)}} \times \text{Frequency limit(Hz)}$$

Steps:

measurement mode→system→Pulse Output→Freq Max(Hz)

Steps	Operation instructions	Interface show
1	Click “▶” into “Freq Max(Hz)”	<div style="border: 1px solid black; padding: 5px;"> Freq Max(Hz) 2000 Max: 5000.0 Min: 100.0 2000 </div>
2	Click “▲” and “▶”key to set “Freq Max(Hz)”,Click “◀” show confirm menu	<div style="border: 1px solid black; padding: 5px;"> Freq Max(Hz) 2000 Max: 5000.0 Min: 100.0 3000 </div>
3	Click “◀” key to confirm and return configuration menu(click”▶” give up modify	<div style="border: 1px solid black; padding: 5px;"> Freq Max(Hz) 2000 <-ENT ESC-> 3000 </div>
4	Click “◀” three times from configuration menu to measurement menu, also you can continue other operation.	



When the Liter/ pulse = 0.0, the case "frequency cap Hz" setting determines the frequency of the output

When the Liter/pulse >0.0, the setting of L/P determines the frequency output

9.) Liter/pulse(L/P)

Scale corresponding to the current flow of output frequency

$$\text{Output Frq (Hz)} = \frac{\text{Current Flow(m}^3\text{/h) /3.6}}{\text{Liter/pulse(L/P)}} = \frac{\text{Current Flow(L/s)}}{\text{Liter/pulse(L/P)}}$$

Steps:

measurement mode→system→Pulse Output→ Liter/pulse(L/P)

Steps	Operation instructions	Interface show
1	Click “▶” into “ Liter/pulse”	<div style="border: 1px solid black; padding: 5px;"> Liter/pulse 0.0000 Max: ----- Min: 0.00555 0.0000 </div>

Steps	Operation instructions	Interface show
2	Click “▲” and “▶”key to set “Freq Max(Hz)”,Click “◀” show confirm menu	<div style="border: 1px solid black; padding: 5px;"> Liter/pulse 0.0000 Max: ----- Min: 0.00555 0.1000 </div>
3	Click “◀” key to confirm and return configuration menu(click” ▶” give up modify	<div style="border: 1px solid black; padding: 5px;"> Liter/pulse 0.0000 <-ENT ESC-> 0.1000 </div>
4	Click “◀” three times from configuration menu to measurement menu, also you can continue other operation.	

10 .) Cumulate Clear

Two ways of the total cumulative flow, its meaning is as follows

1 $\Sigma +$, means symbol "+ 'cumulative value of the flow

2 $\Sigma -$, means symbol ' - " cumulative value of the flow

Select cumulate cleared, the total amount of the above two are forced to zero, cannot be recovered if don't save before. Clear cumulate as follows

Steps:

measurement mode → system → Total set → Clear Total

Steps	Operation instructions	Interface show
1	Click “▶” into “Clear Total”	<div style="border: 1px solid black; padding: 5px;"> Clear Total No No </div>
2	Click “▼” key to change “No” to “Yes”	<div style="border: 1px solid black; padding: 5px;"> Clear Total No Yes </div>
3	Click “◀” to show confirm menu	<div style="border: 1px solid black; padding: 5px;"> Clear Total No <-ENT ESC-> Yes </div>

Steps	Operation instructions	Interface show
4	Click “◀” to show again confirm menu	<div style="border: 1px solid black; padding: 10px; width: fit-content; margin: auto;"> <p>Clear Total <-Yes No-></p> </div>
5	Click “◀” key to confirm and return configuration menu(click “▶” give up modify	
4	Click “◀” three times from configuration menu to measurement menu, also you can continue other operation.	

V、Technical data

Sensors range	DN10 – DN3000
Measurement Flow range	0.03m/s -12m/s (Advice rangebetween 0.3m/s-10m/s)
Measurement Accuracy (relative with sensor diameter)	1、 0.5 m/s-10 m/s: +0.5% (User select+0.3%、 +0.2%) (Relate with sensor diameter) 2、 0.3 m/s-0.5 m/s: +0.5%
Repeatability	0.25%/0.1% (According Accuracy demand)
Environment Temperature	-20°C-55°C
Power supply	AC:85-265V,45-62Hz;DC: 18-36V
Power rating	AC: 10 VA; DC: 10W
Grade of Protection	IP65 IP67
Output	1 power output : 4-20mA load is less than 750Ω 2 frequency output 0 5KHz (active or passive), maximum amplitude of 24V, load current 50 3 Pulse Output: can be set equivalent pulse, pulse frequency of 0.006Hz-5KHz (active or passive), Load current o.2
Communication	RS485 Modbus or HART
Display	English show display instantaneous flow rate, positive cumulative volume, the reverse cumulative amount of net accumulated Volume, flow rate percentage, velocity and various self-diagnostic information Current output self-calibration;
Control methods	Three key
Low cut off %	0.0%~9.9% adjusts (for Display or output)
Damping time	0.1s~99.9s adjusts (for Display or output)
Auto Trim	Current output self-calibration; Empty/full Trim; Zero Trim
Self-test function	Current frequency output self-test
self-diagnostic function	Excitation loop detection; Zero ,Empty and flow signal detection
Explosion proofing	Explosion proofing symbol Ex[ia]ia IICT5

VI、 Error information

Error	Contents	Reason
Upper limit	Flow measurement value over than the upper limit value alarm	Limit alarm set value is lower than the flow measurement, modify the upper limit alarm settings
Lower limit	Flow measurement value lower than the lower limit value alarm	Limit alarm set value is over than the flow measurement, modify the lower limit alarm Settings
Excitation	Excitation circuit is not working correctly	<p>A) check cables terminal and electrical excitation of the terminal connection is good or not</p> <p>B)check the sensor excitation circuit don't existence of open or short circuit</p> <p>C excitation coil temperature is too high</p> <p>D excitation frequency set too high</p>
Empty tube	Empty tube stage is show zero or random data.	<p>A)flow meter sensor is not full of medium</p> <p>B) electrode surface was completely covered by insulating layer</p> <p>C) signal lines to connect the signal is incorrect or open loop</p> <p>D)measuring low conductivity medium</p> <p>E)empty and full trim is not correct, or tube region % is high sensitivity settings</p>
Zero point	Zero point value too High on zero trim	<p>A) on the zero trim time, the flowmeter sensor medium in a state of non-full pipes</p> <p>B)on the zero trim time, the sensor tube in a non-static state media</p> <p>C) flowmeter grounding is incorrect or unreliable and technical requirements of re-grounding</p>
Over range	Instant value exceeds instrument declare value	<p>Over the instruments max allow the value, pls re-select the more</p> <p>Large diameter of the flowmeter</p>

VII、 Common failures and how to deal with

1、 No flow data show on LCD

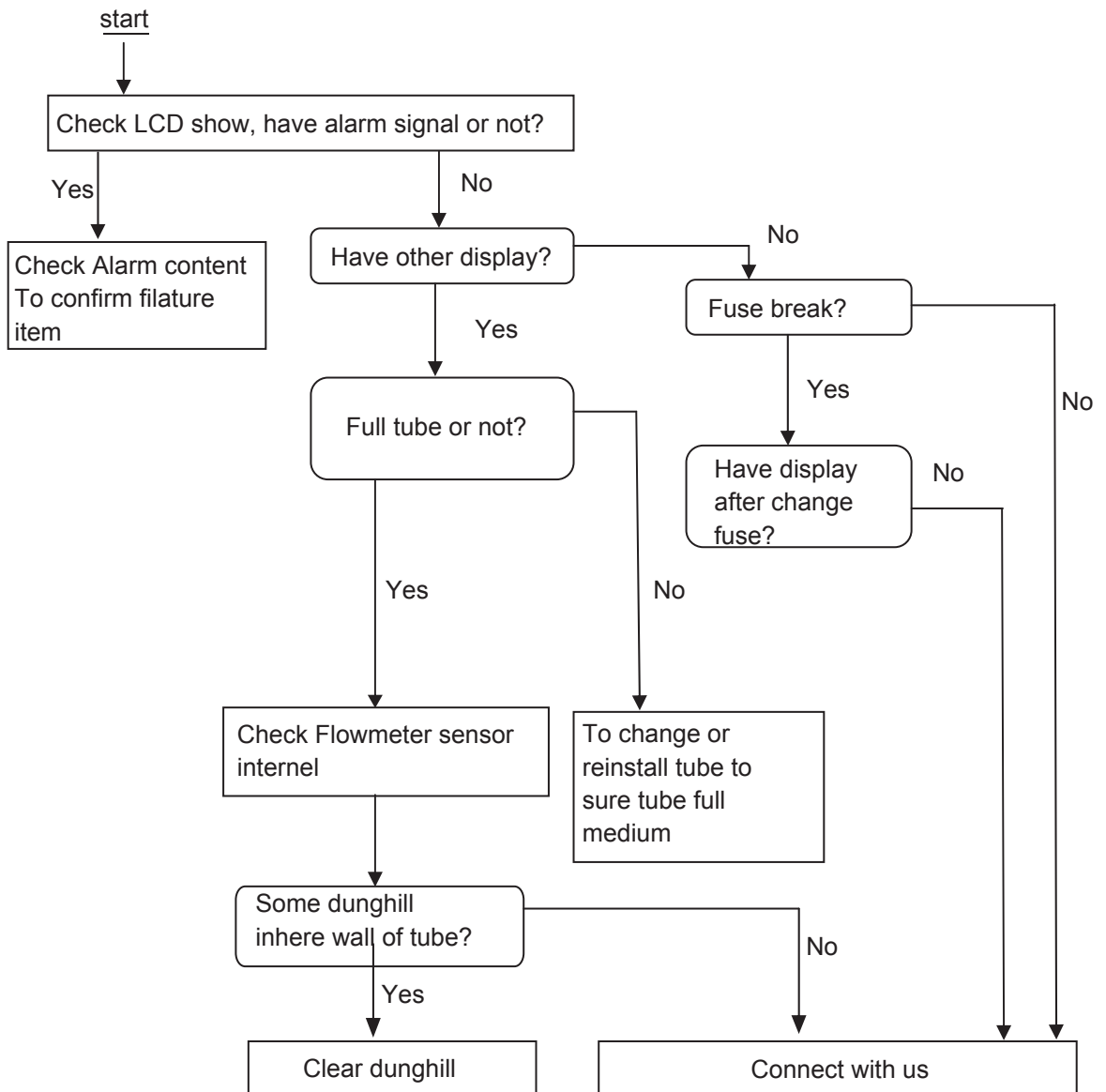

2. Zero point instability

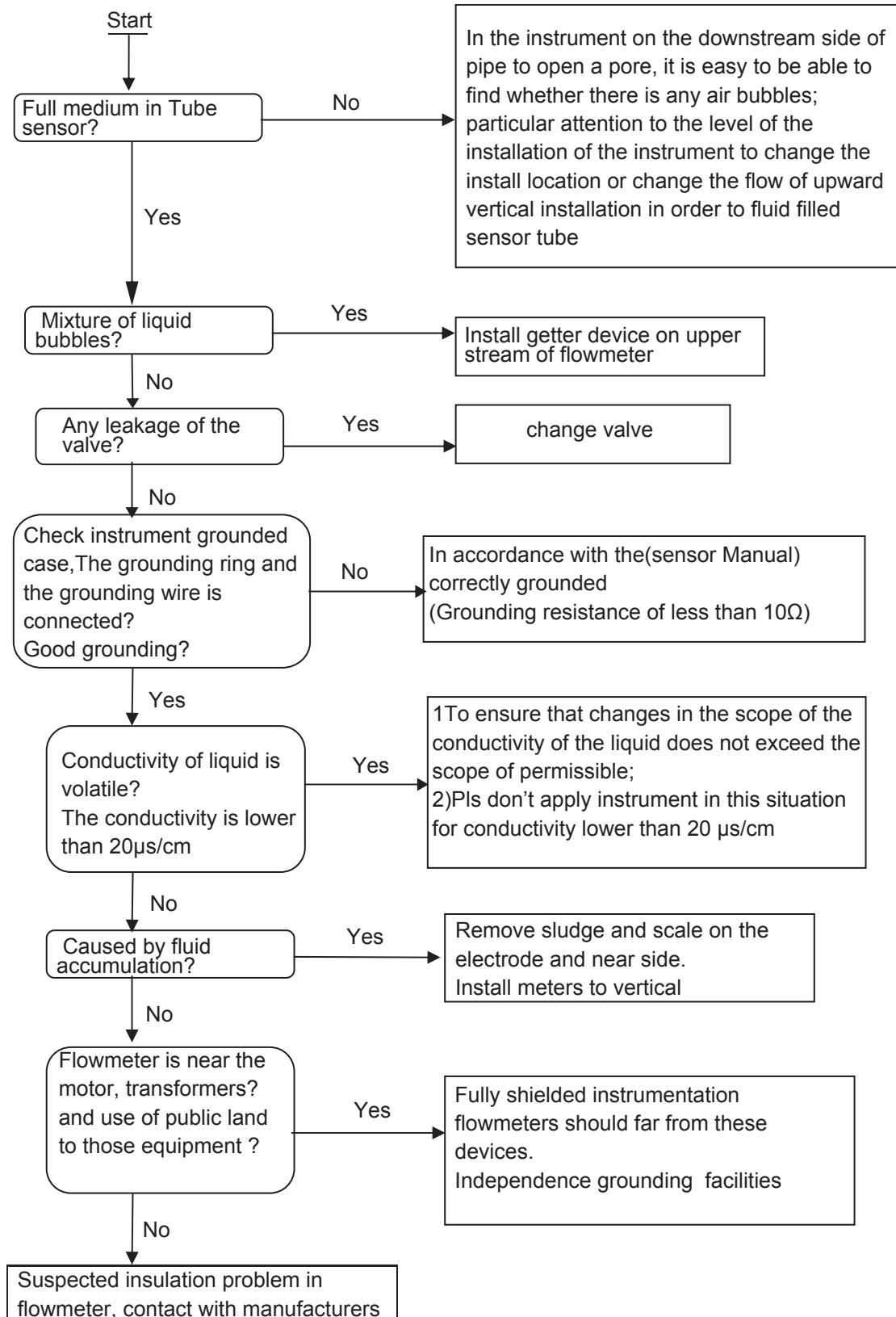

3、 Instrument show data inconsistent with the actual flow

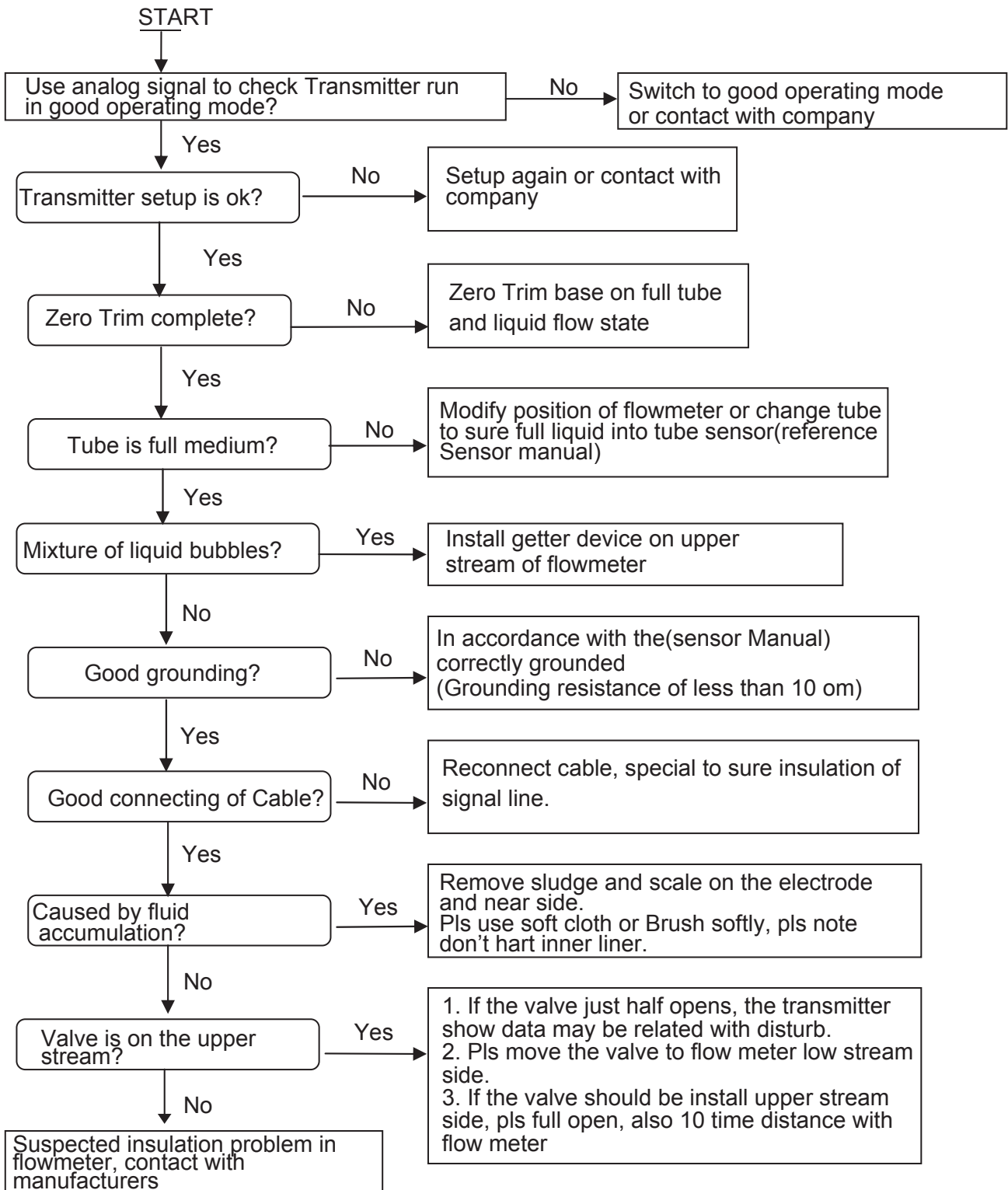

VIII. Order

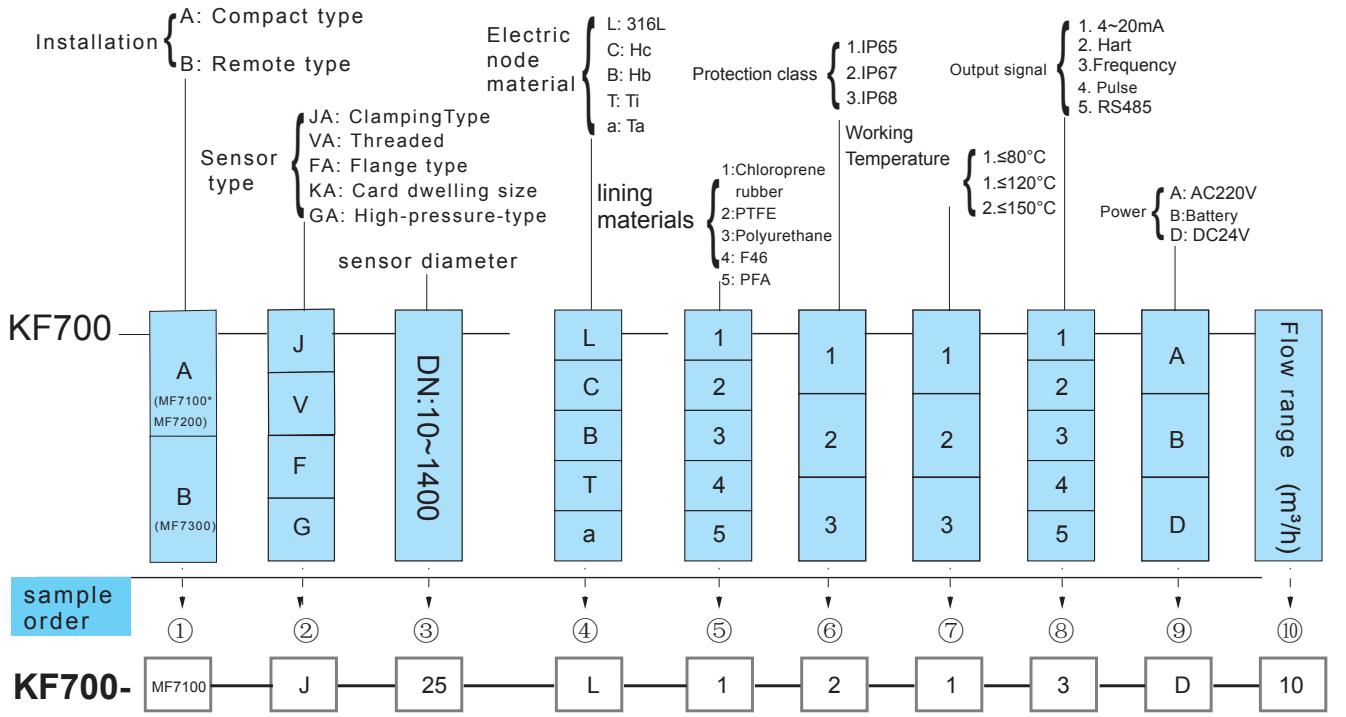

VIII. Transportation, storage

In order to avoid transport and storage of the occurrence of unnecessary damage, in the process of transport and storage of the following items should be noted that

1) In order to prevent the functioning of the process of instrument in damage and lost, before arrival at the installation site, please keep the packaging when the company shipped state.

2) To be handled carefully during transportation to avoid brutal to loading and unloading.

3) Arrived at the scene should be carefully unloaded, in accordance with the contents of each item packing list check, if missing or not in conformity for those issues, pls contact with the company.

4) Instrument storage sites must meet the following requirements for indoor

- a) drying, ventilation and avoid erosion of corrosive gas
- b) a small mechanical vibration to avoid the impact to flowmeter.
- c) Environment temperature range. -20 ~ 60°C
- d) The humidity should be small than 80%;

5) If instrument doesn't use for a longer term, Pls keep good protection as the factory instrumentation.



NingBo KIO Flow Instruments Co.,LTD

Add:No.20 XingYe Rode,YuYao City,ZheJiang Province,China

Tel: 0574-62502088 62502089 62502099

Fax: 0574-62502091 62502092

P. O. : 315400

Http: // www.flowmeter.cc

E-mail: info@flowmeter.cc